

SAMI 2016

**IEEE 14th International Symposium
on Applied Machine Intelligence
and Informatics**

PROCEEDINGS

January 21–23, 2016

Herľany, Slovakia

IEEE Catalog Number: CFP1608E-USB
ISBN: 978-1-4673-8739-2

Copyright and Reprint Permission: Abstracting is permitted with credit to the source. Libraries are permitted to photocopy beyond the limit of U.S. copyright law for private use of patrons those articles in this volume that carry a code at the bottom of the first page, provided the per-copy fee indicated in the code is paid through Copyright Clearance Center, 222 Rosewood Drive, Danvers, MA 01923. For reprint or republication permission, email to IEEE Copyrights Manager at pubs-permissions@ieee.org. All rights reserved. Copyright ©2016 by IEEE.

COMMITTEES

HONORARY CHAIR

Lotfi A. Zadeh, USA

HONORARY COMMITTEE

Ljiljana Trajkovic, Simon Fraser University, Canada
Stanislav Kmet, Technical University of Košice, Slovakia
János Fodor, Óbuda University, Budapest, Hungary
Liberios Vokorokos, Technical University of Košice, Slovakia
Anton Čižmár, Technical University of Košice, Slovakia

GENERAL CHAIRS

Imre J. Rudas, Óbuda University, Budapest, Hungary
Peter Sinčák, Technical University of Košice, Slovakia

TECHNICAL PROGRAM COMMITTEE CHAIRS

Szilveszter Kovács, University of Miskolc, Hungary
Jan Paralič, Technical University of Košice, Slovakia
Ivana Budínska, Slovak Academy of Science, Slovakia

INTERNATIONAL ORGANIZING COMMITTEE CO-CHAIRS

Marián Bucko, Elfa, Slovakia
József Gáti, Óbuda University, Budapest, Hungary
Ladislav Főző, Technical University of Košice, Slovakia

MADARÁSZ SPECIAL SESSION CO-CHAIRS

Rudolf Andoga, Technical University of Košice, Slovakia
Ladislav Főző, Technical University of Kosice, Slovakia
Vladimír Gašpár, Technical University of Kosice, Slovakia
Jan Vaščák, Technical University of Kosice, Slovakia

TECHNICAL PROGRAM COMMITTEE

Rudolf Andoga, Technical University of Košice, Slovakia
František Babič, Technical University of Kosice, Slovakia
Péter Baranyi, SZTAKI, Hungary
Peter Bednár, Technical University of Kosice, Slovakia
Balázs Benyó, Széchenyi István University, Győr, Hungary
Manuelle Bonacorossi, Scuola Superiore Santana, Italy
Marek Bundzel, Technical University of Košice, Slovakia
György Eigner, Óbuda University, Budapest, Hungary
Tamás Ferenci, Óbuda University, Budapest, Hungary
Ladislav Főző, Technical University of Košice, Slovakia
Róbert Fullér, Óbuda University, Budapest, Hungary
Alena Galajdová, Technical University of Košice, Slovakia
Tamás Haidegger, Óbuda University, Budapest, Hungary
Mikuláš Hajduk, Technical University of Kosice, Slovakia
László Horváth, Óbuda University, Budapest, Hungary
Ján Jadlovský, Technical University of Košice, Slovakia
Rudolf Jakša, Technical University of Košice, Slovakia
Aleš Janota, University of Žilina, Slovakia
Csaba Johanyák, Kecskemét College, Hungary
Levente Kovács, Óbuda University, Budapest, Hungary
Dusan Krokavec, Technical University of Košice, Slovakia
Marian Mach, Technical University of Košice, Slovakia

Kristína Machová, Technical University of Košice, Slovakia
Vladimír Modrák, Technical University of Košice, Slovakia
Igor Mokris, SAV Bratislava, Slovakia
Marek Penhaker, VŠB Ostrava, Czech Republic
Martin Sarnovský, Technical University of Košice, Slovakia
Johanna Sági, Óbuda University, Budapest, Hungary
Salvadore Sessa, Waseda University, Japan
Juraj Špalek, University of Žilina, Slovakia
Ágnes Szeghegyi, Óbuda University, Budapest, Hungary
Sándor Szénási, Óbuda University, Budapest, Hungary
Árpád Takács, Óbuda University, Budapest, Hungary
Márta Takács, Óbuda University, Budapest, Hungary
József K. Tar, Óbuda University, Budapest, Hungary
József Tick, Óbuda University, Budapest, Hungary
Kaori Yoshida, Kyushu Institute of Technology, Japan
Zoltán Vámosy, Óbuda University, Budapest, Hungary
Annamária R. Várkonyi-Kóczy, Óbuda University, Hungary
Jan Vaščák, Technical University of Košice, Slovakia
Terez Várkonyi, Óbuda University, Budapest, Hungary
Maria Virčíková, Technical University of Košice, Slovakia
Jozef Živčák, Technical University of Košice, Slovakia
Iveta Zolotova, Technical University of Košice, Slovakia

SECRETARY GENERAL

Anikó Szakál
Óbuda University, Budapest, Hungary
 E-mail: szakal@uni-obuda.hu

Iveta Zamecnikova
Technical University of Košice, Slovakia
 E-mail: zamecnikova@elfa.sk

Community-based Routing Scheme for Future Internet Considering PLM Systems	205
Yatish Bathla <i>Óbuda University, Budapest, Hungary</i>	
Nonlinear Soft Tissue Mechanics Based on Polytopic Tensor Product Modeling.....	211
Árpád Takács*, Tamás Haidegger*,****, Péter Galambos*, József Kuti**,***, Imre J. Rudas* * <i>Óbuda University, Budapest, Hungary</i> ; ** <i>Budapest University of Technology and Economics, Hungary</i> ; *** <i>Institute for Computer Science and Control, Hungarian Academy of Sciences, Budapest, Hungary</i> ; **** <i>Austrian Center for Medical Innovation and Technology, Wiener Neustadt, Austria</i>	
Brain-Computer Interface and Arduino Microcontroller Family Software Interconnection Solution	217
Branislav Madoš, Norbert Adam, Jan Hurtuk, Marek Čopjak <i>Technical University of Košice, Slovak Republic</i>	
Mapping of machine faults using tools of World Class Manufacturing	223
A. Novická, P. Papcun, I. Zolotová <i>Technical University in Košice / Department of Cybernetics and Artificial intelligence, Košice, Slovakia</i>	
Enterprise Search / Search over Corporates Systems	229
Stanislav Dvorščák, Kristína Machová <i>FEI TU of Košice, Slovak Republic</i>	
Selecting Fatigue Critical Inspection Location of Offshore Topside Piping Using Fuzzy-AHP Framework...235	
Arvind Keprate, R. M. Chandima Ratnayake <i>Department of Mechanical and Structural Engineering and Material Science, University of Stavanger, Norway</i>	
The Effect of the Diffuse Irradiation on the PV Plants' Production	241
Péter Kádár <i>Óbuda University Budapest, Hungary</i>	
Studying Combined Breast Cancer Biomarkers using Machine Learning Techniques	247
Dina T. Saleh, Amir Attia, Olfat Shaker <i>Cairo University, Egypt</i>	
Accuracy of Person Identification Based on Public Available Data	253
Ján Mojžiš*, Michal Laclavík** * <i>Institute of Informatics, SAS, Bratislava, Slovakia</i> ; ** <i>Magnetic Media Online, New York, USA</i>	
Emergency Horn Detection Using Embedded Systems	257
Josef Palecek, Martin Cerny <i>VSB – TU Ostrava, Czech Republic</i>	
Assessment of Education Process Management.....	263
Z. Chaczko*, R. Klempous**, J. Nikodem**, J. Rozenblit*** * <i>University of Technology, Sydney, Australia</i> ; ** <i>Wroclaw University of Technology, Poland</i> ; *** <i>The University of Arizona, Tucson, AZ, USA</i>	
Numerical Investigation of Vortex Ring State of Tail Rotor and Uncontrolled Rotation of Helicopter.....	269
Peter Gasparovic, Radovan Kovacs, Ladislav Fozo <i>Technical University of Kosice, Slovak Republic</i>	
The Use of Topic Identification in Opinion Classification.....	275
Martin Mikula and Kristína Machová <i>Technical University Košice</i>	
Research Activities of the Center of Modern Control Techniques and Industrial Informatics.....	279
J. Jadlovský*, A. Jadlovská, S. Jadlovská, J. Čerkala, M. Kopčík, J. Čabala, M. Oravec, M. Varga, D. Vošček <i>Technical University of Košice, Slovakia</i>	
Motion Sensor Data Correction using Multiple Sensors and Multiple Measurements	287
Tibor Tajti*, Nagy Benedek** * <i>Eszterházy Károly College, Eger, Hungary</i> ; ** <i>University of Debrecen, Debrecen, Hungary</i>	
Parallel Usage of Multiple Optimization Algorithms for Searching Different Candidate Spaces.....	293
Tomáš Cádrik, Marián Mach <i>Technical university of Košice, Slovakia</i>	
The Inverse Kinematics Problem, a Heuristical Approach	299
Claudiu Radu Pozna*,**, Ernő Horváth*, János Hollósi* * <i>Széchenyi István University, Győr, Hungary</i> ; ** <i>Transylvania University, Brasov, Romania</i>	

Research Activities of the Center of Modern Control Techniques and Industrial Informatics

J. Jadlovský*, A. Jadlovská, S. Jadlovská, J. Čerkala, M. Kopčík, J. Čabala, M. Oravec,
M. Varga, D. Vošček

Technical University of Košice, Faculty of Electrical Engineering and Informatics,
Department of Cybernetics and Artificial Intelligence, Košice, Slovakia

*jan.jadlovsky@tuke.sk

Abstract— One of the research activities of the Center of Modern Control Techniques and Industrial Informatics (CMCT&II) is the *Center for Nondestructive Diagnostics of Technological Processes (CNDTP)* implemented as part of the *TECHNICOM* project at the Technical University of Košice in accordance with the project's intention to improve conditions for transferring research results into practice. The focus of the Center's research is on nondestructive, contactless diagnostics of technological processes relying on image recognition systems where images are scanned by means of contact-free characteristics scanning through grayscale, color or thermovision cameras. This equipment is integrated into the control systems of technological processes and interconnected with the mechatronic parts of technological devices or production lines such as servo systems, mobile and manipulator robots. Our project therefore involves a wide range of technical, programming and networking resources which allow the development, experimental verification and adjustment of solutions related to monitoring, diagnostics and control of technological processes.

I. INTRODUCTION

The presented paper deals with the distributed control systems (DCS) of technological processes in the wide range of control, with the focus on ensuring the high level of quality and reliability of the whole control system as well as its individual distributed parts (Fig. 1). Besides the sensors and actuators used in technological process

control, the structure of control system enables the implementation of additional sensors which may not directly influence the control input, but they may provide additional information about the technological process, such as the evaluation of control quality. Such sensors are generally of a nondestructive kind and include cameras/camera systems, pyrometers, laser/ultrasound/induction sensors, sensors based on eddy currents etc. Information from these sensors is integrated with information from sensors and actuators which appear in feedback control loops of the technological process. In the following step, they are compared to process requirements (especially related to control quality), which are defined in the reference model created particularly for this purpose.

This paper describes the proposed approach for the implementation of DCS for technological processes. All parts of the paper will describe the methodology of DCS design for a particular field, control algorithms and their verification via modeling/simulation, and finally, physical realization using a wide range of hardware, software and networking components with the focus on their application in quality monitoring and control [1]. Given the wide application of the DCS-related issues, the paper is structured into thematic sections dealing with:

1. mechatronic systems related to mobile robotics,
2. complex mechatronic systems with the focus on

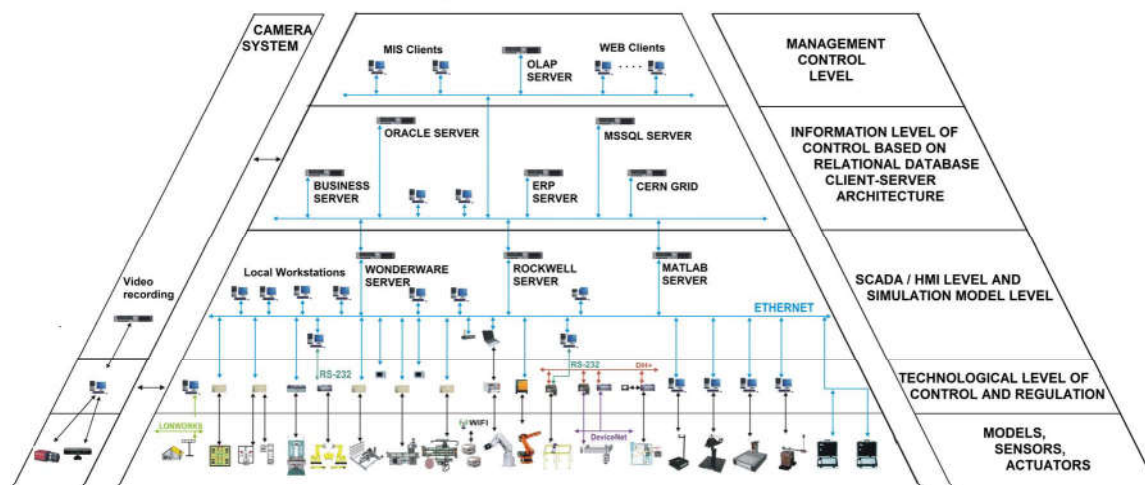

Figure 1. Distributed control system (DCS) pyramidal model implemented at the Department of Cybernetics and Artificial Intelligence

design and implementation of control algorithms for fully actuated and underactuated systems,

- mechatronic systems related to production lines including industrial robots and manipulators.

In each the listed sections, we describe how systems of nondestructive diagnostics, such as camera systems, are used as an integral part of analyzed model applications.

II. DISTRIBUTED CONTROL DESIGN AND DIAGNOSTICS FOR MECHATRONIC SYSTEMS

A. Diagnostic problem solving for mobile robots – mobile robot workplace

The proposed methodology for solving control and diagnostics problems of mobile robots involves modeling, simulation, control, and physical realization of mobile robot systems in typical applications. In addressing these problems, we proposed an approach based on two types of model applications:

- simulation models, created by implementing the derived mathematical models of the particular types of mobile robots with corresponding control systems in a suitable programming environment,
- physical realization of laboratory models of wheeled and tracked mobile robots together with actuators, control and sensory systems.

Mobile robot diagnostics rely on the fusion of results obtained by offline/online mathematical model simulation and the data from laboratory robot sensors.

Mathematical modeling, control and simulation of mobile robots

The mobile robot can in general be represented by a mathematical model composed of a kinematic and a dynamic part, both obtained using known physical relationships. Kinematic model defines the geometric properties of mobile robot movement with respect to the chassis construction, while the dynamical model reflects the impact of robot mass, inertia, friction and motor dynamics on the overall movement of the robot.

Mathematical models of mobile robots can be implemented in *MATLAB/Simulink* and later used to verify the functionality and stability of control structures for specified control objectives. The first proposed model application is a problem-oriented *Simulink* library which contains reconfigurable simulation models of differentially driven mobile robots. An example model block is depicted in Fig. 2. The library also includes visualization tools based on *OpenGL* which are useful in the diagnostics of model behavior for selected inputs. Mathematical and simulation models from the developed library, together with control algorithms, can later be used in the design and programming of real – laboratory models of mobile robots [2].

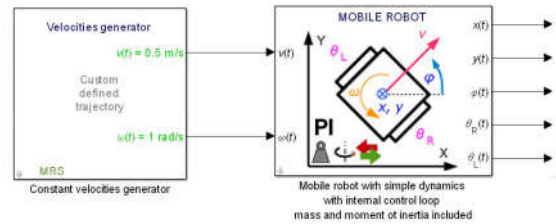

Figure 2. Simulation model of mobile robot with differentially driven wheels

Laboratory models of mobile robots

Development of laboratory models of mobile robots consists of the design of mechanical and electronic parts. The mechanical part can be designed and modelled using *CAD*-like software (*SolidWorks*, *AutoCad*), while the *Eagle* and *Proteus* software are used for electronics design and simulation, respectively. In terms of minimization of size, weight and energy consumption, microcontrollers such as the *Microchip*, *Atmel*, *STMicroelectronic* and *Raspberry Pi* are most often selected as the best option for a control unit. To ensure the redundancy of measured mobile robot parameters, it is possible to use absolute/relative position sensors such as gyroscopes, compasses, accelerometers, ultrasound and infrared sensors, special camera systems or DC motor position incremental sensors. Remote control and sensory data acquisition is performed using standard wireless interfaces such as *Bluetooth* (short-distance) and *WiFi*.

The selected control unit determines the choice of development environment (*MPLAB*, *Atmel Studio*, *Keil μVision*). Control applications for the mobile robot are mostly developed in *C/C++*, while *C#* and *JAVA* are suitable for programming the HMI applications. In the second proposed model application, differentially driven two-wheeled mobile robots were designed and constructed: robot fulfilling the *MiroSot* robosoccer rules (Fig. 3) along with a tracked mobile robot, *TrackBot*.

The developed mobile robot workplace enables us to solve various diagnostics tasks such as fault detection in sensors and actuators, or the detection of abnormalities in system states (Fig. 4). Such fault states can be detected by combining data from redundant onboard sensors, or by using multiple camera systems in the workplace [3].

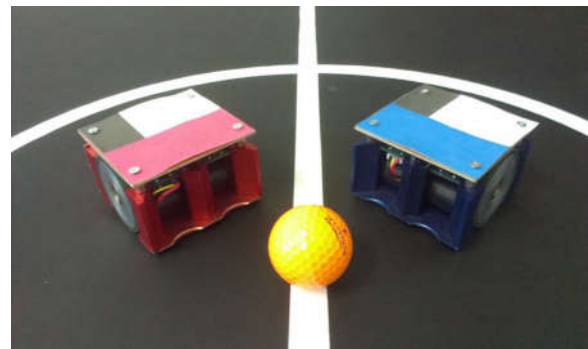

Figure 3. Soccer robots of the *MiroSot* category on a laboratory playground



Figure 4. Laboratory workplace for the mobile robot control and diagnostics – conceptual scheme

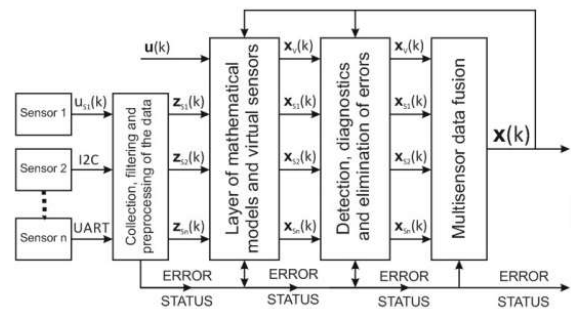

Figure 5. Block diagram of sample diagnostics

Computer vision system

Since integration-based positioning methods (inertial sensors, wheel rotation tracking, etc.) accumulate error over time, an overhead camera is used to periodically correct robot positions. In conjunction with other sensors, a computer vision systems provides accurate and fast positioning without continuous error accumulation.

Originally developed for robotic soccer, the image processing algorithm is able to detect mobile robots of arbitrary shape and appearance. This is achieved by general motion detection and blob tracking based on background modelling. This approach was chosen for the robotic soccer application, where it is necessary to track opponents of unknown appearance. Gaussian distribution-based background modelling also provides enough resistance to low frequency environment noise, such as shadows cast by people walking around the field, which would otherwise cause unwanted false detections. In robotic soccer, the algorithm also tracks the ball and identifies our players and their roles by the custom color pattern on the top side of the robots [4].

Non-destructive diagnostics of mobile robots

The proposed methodology for diagnostic tasks is based on the assumption that considered mobile robots contain redundant sensors, and that reference models of mobile robots are available. The goal is to ensure insensitivity to various external disturbance variables (Fig. 5). Using known control effort values and reference models, it is possible to estimate faultless mobile robot behavior which serves as a reference for the detection of previously unknown disturbances affecting the mobile robot during control. Moreover, mobile robot sensory data are logged into the database to allow offline diagnostics and evaluation of control quality against the reference model. The comparison of reference model and laboratory model responses can be visualized as a 3D animation. The proposed methodology for diagnostics can be used in service robotics, in mobile robot systems with requirements for improved reliability, or with limited service options.

B. Diagnostic problem solving for mechatronic systems – model workplace

The presented approach for solving control and diagnostics problems of fully actuated and underactuated

dynamical systems is based on the proposed methodology which involves modeling, simulation, control and physical realization of mechatronic/hydraulic systems in typical applications. Once again, our approach is based on two basic types of model applications:

1. simulation models created by implementing the derived mathematical models of the typical representatives of fully actuated and underactuated systems into a suitable simulation environment,
2. physical realization of laboratory models of mechatronic/hydraulic systems with built-in sensors, actuators and control systems (based on micro-controllers, technological PCs and PLC automata), related to their simulation models and the DCS pyramid infrastructure.

Diagnostics of mechatronic systems is based on the comparison of dynamical responses of simulation models to the sensor outputs of laboratory models in model applications. Depending on the nature of the mechatronic system, approaches such as online/offline *experimental* identification, spectral analysis based on fast *Fourier* transformation and image recognition are used to solve diagnostics tasks. The model workplace developed for solving problems of nondestructive diagnostics of mechatronic systems is composed of laboratory models and model applications (classical inverted pendulum with a linear synchronous motor, ball & plate, hydraulic system) which allow to implement the proposed methodology of modeling, control and diagnostics in a suitable program environment [5].

Classical Single Inverted Pendulum Model – implementation into the DCS

Model application composed of a laboratory model of a classical single inverted pendulum (i.e. pendulum on a cart) with a built-in linear synchronous motor represents an intelligent positioning mechanical system which allows to solve accurate positioning problems in unstable mechanical devices as well as the convey-crane problem, i.e. manipulation of the load hanging on the rope given the defined swing tolerances [6]. The model application (Fig. 6) implements the proposed methodology composed of mathematical modeling of underactuated mechatronic systems and their simulation in *MATLAB/Simulink*, as well as the design and implementation of stabilizing control algorithms using the industrial PC or the PLC [7]. The application also allows to visualize the controlled

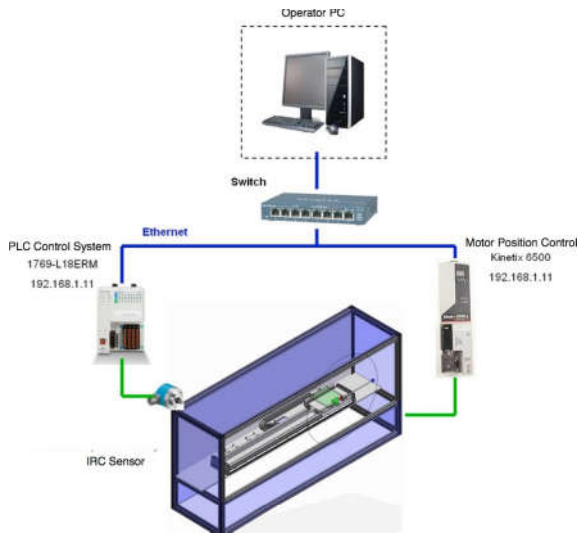

Figure 6. Laboratory workplace for the inverted pendulum model – conceptual scheme

mechatronic process in connection to SCADA and higher levels of the DCS infrastructure (Fig. 1).

The technical solution of the model application was designed so as to reflect the DCS pyramid infrastructure (Fig. 1). The individual subsystems of the model application will now be analyzed with respect to their relationship with the defined levels of the pyramid model.

The *level of models, sensors and actuators* is represented by the mechanical construction of the inverted pendulum system with a linear synchronous motor. Motor position is captured by an incremental position sensor with the precision of 1000 impulses/mm. The cart is assumed to be part of the motor armature (stator). The end positions of the stator are captured by a pair of induction position sensors. The angle of the pendulum rod, attached to the cart, is captured by the KINAX-2W2 programmable angle converter with the precision of 220 impulses/degree.

At the *technological level of control/regulation*, control of the motor position is performed via the KINETIX 6500 servomotor with frequency converter, which is connected to the CompactLogix PLC via the Ethernet. Since the stabilization of inverted pendulum systems requires fast controller responses, motor and pendulum position sensors are connected to the programmable inputs of KINETIX 6500. Implementation of control algorithms at the PLC level is performed via RSLogix 5000.

The *SCADA/HMI & simulation model level* is predominantly represented by a simulation model of the inverted pendulum model implemented in MATLAB/Simulink. Parameters of the simulation model are determined either by measuring the mechanical characteristics of the inverted pendulum (e.g. rod length, weight mass) or, in the case of motor velocity control, obtained by experimental identification. Using a suitable control algorithm, the sequence of control input values is next computed and transferred into the PLC, which defines real-time control of the laboratory model. Finally, Wonderware InTouch can be used to visualize the process

of inverted pendulum control. Interconnection of the SCADA/HMI level with the lower (*technological*) level, as well as the higher levels of DCS infrastructure (MATLAB/Simulink vs. the ORACLE database system) takes place via the OPC server using the RSLinx module.

The proposed methodology of control and diagnostics depends on the knowledge of system parameters, obtained by measurement or experimental identification. Design and implementation of control algorithms can therefore be performed in real time, with high accuracy, all while reflecting the DCS infrastructure [7].

The newest addition to the inverted pendulum model application is a camera system with a set of replaceable cameras which include thermovision cameras, line CCD cameras, board grayscale/color CCD cameras and 3D cameras. The camera system provides additional useful information about the model, such as the changes in motor temperature with respect to the load, and position changes of model components. It also enables monitoring of surface defects of a product placed on the moving cart (via a fast scanner based on line camera), monitoring and evaluation of 3D objects (via a combination of line laser and a board camera, or via 3D cameras). The presented model workplace can therefore be used to solve an extended set of control and diagnostics problems of technological processes based on proposed methodology.

Intelligent Positioning Mechatronic System

Model application composed of the *Ball & Plate* laboratory model in general represents an intelligent positioning mechatronic system based on the concept of position control of an object moving on an adjustable plate. This application provides a platform for mathematical modeling and subsequent simulation of a mechatronic system in MATLAB/Simulink, but also for the implementation of designed control algorithms, with the diagnostics realized via the technological PC or the PLC. The application also allows to visualize the controlled mechatronic process in connection to SCADA and higher levels of the DCS infrastructure.

The *Ball & Plate* laboratory model consists of the servomotor subsystem, the plate subsystem and a ball whose position coordinates are determined using a fixed camera (Fig. 7). Communication between the laboratory model and the PC is provided via a microcontroller

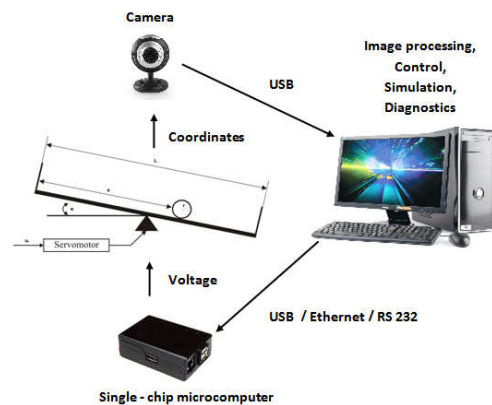

Figure 7. Laboratory workplace for the ball & plate model – conceptual scheme

through serial connection. The specific design solution of the model enables the implementation and verification of proposed control algorithms in various programming languages (C/C++/C#) or simulation tools (*Matlab/Simulink*). Control and diagnostics of the application are based on the experimentally identified system parameters which allow to compare the reference model response to the camera system output [8].

Two-Tank Hydraulic System Laboratory Model

Model application composed of the *Hydraulic system* laboratory model represents a real-life system based on hydraulic principles. The main goal of this application is to verify diagnostic methods in conditions determined by the specific nature of this system. From the diagnostics point of view, it is particularly important to secure critical levels of monitored variables: failure to do so could result in an emergency state during system operation.

The hydraulic system laboratory model consists of a set of two cascade-connected cylindrical tanks (Fig. 8). Liquid is pumped into the top tank from the reservoir located at the bottom of the model using a membrane pump, and the level in both tanks is measured using *Dinel* capacitive sensors. Control algorithms can be implemented directly into the PLC, or ran indirectly via a connected technological PC which is part of the model workplace; communication is ensured through the *OPC/DDE* interface (Fig. 9). Reference mathematical model of the system can be obtained via analytical or experimental identification with the aim of its application in control algorithm design and diagnostics [9].

C. Flexible manufacturing systems: automated and robotized production lines

This model application includes laboratory models of production lines, i.e. the *Flexible Production System* (FPS) and the *Flexible Assembly Company* (FAC) with the *Mitsubishi MELFA RV-2SDB* robotic arm [10]. It allows to perform nondestructive diagnostics based on reference models of production process. These are obtained by suitable methods for describing discrete-event systems such as the *Petri nets* [1] and *Stateflow* diagrams [11].

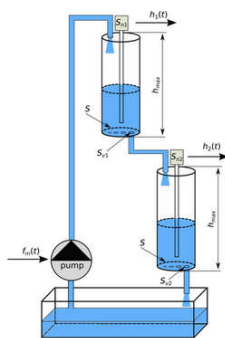

Figure 8 Laboratory workplace for the hydraulic system control and diagnostics – conceptual scheme

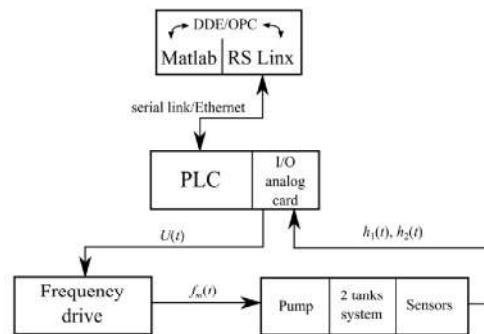

Figure 9. Laboratory workplace for the hydraulic system control and diagnostic – block scheme

Distributed control system in production lines

The distributed control system designed for the FPS/FAC production lines implements all five levels of the DCS pyramid model depicted in Fig. 1. Sensors (*optical, ferromagnetic, laser*) and actuators (*stepper/DC motors, pneumatic pistons*) at the individual manipulator posts are interconnected by a variety of communication networks and protocols (*Ethernet, Ethernet/IP, ASi, ProfiBus, DeviceNet, FireWire, RS-232*). Both production lines are controlled by *Compact Logix PLC* automata. At the SCADA/HMI level, control can be performed directly from the workstation via *RS Logix 5000*, or using the *Panel View Plus* touchpanel. Visualization is performed via *FT View* or *InTouch*. Data obtained from sensors are stored in relational *Oracle* databases to ensure the *Enterprise Resource Planning* or *Manufacturing Resource Planning* functionality. Above this data, multidimensional databases for management control level are created by means of *OnLine Analytical Processing* via *Oracle Discoverer, Analytic Workspace Manager* or *Oracle Business Intelligence*. These tools make use of production data stored in relational databases, transform them into multidimensional form (data cubes) and enable users to look at the data from different points of view. These viewpoints allow managers to perform analyses which result in helpful production information (reject rate, production time, downtime length, production efficiency), necessary for subsequent optimization of production process and gaining an competitive advantage. At the same time, both production lines constituting the model workplace for nondestructive diagnostics contain a post where camera systems (color/grayscale) perform image/shape recognition. Based on the reference model and sensor parameters, it is possible to determine the quality of the production process with sufficient accuracy. In general, the more accurate the reference model gets, the more faults can be diagnosed in the ongoing production process.

Production line modeling using Petri nets

Petri nets, defined as a bipartite oriented graph with two types of nodes (places/transitions), represent a popular methodology for discrete-event system description and can therefore be used for production line modeling. Designing a model using Petri nets consists of modeling the main and side events, dispensers and

looping production. The Petri net model of the FPS production line, created in *CPNtools*, is depicted in Fig. 10. After defining the initial states, the model can be expressed in a matrix form suitable for implementation into *MATLAB*. Time optimization of transitions between the states of production process can subsequently be performed.

Production line modeling using Stateflow diagrams

An alternative to the production line model created via *Petri* nets is the reference model based on state diagrams, which can be implemented into *MATLAB/Simulink* using the *Stateflow* toolbox. As an example, a simulation model of the FAC is depicted in Fig. 11. The first two blocks of the model are responsible for initialization, while the third one models the main production process.

Non-destructive diagnostics in production lines

The reference model describing the states and transitions in a production line illustrates the required behavior of the device during production. As a result, it can be used in diagnostics to identify narrow/critical points of the production process or to determine optimal production times of particular threads. With the aid of built-in sensors, the PLC continually captures the transitions between states of the production process. If there is a difference between captured data and reference values, it is possible to detect the emerging disturbance or to modify the control effort to suppress it. Introduction of additional camera systems enables us to expand the possibilities of existing diagnostics and also to reveal process faults caused by the depreciation of actuators or random occurrences. Examples include using a thermovision camera to detect undesirable friction or motor overheating, which are impossible to sense by built-in sensors or the naked eye (Fig. 12).



Figure 12 Flexible assembly company laboratory model – camera post

III. CONCLUSION

The presented paper deals with the current research activities, approaches and technologies for monitoring, control and diagnostics of technological processes in CMCT&II, which involve the evaluation of qualitative parameters of the production process and final products. In CMCT&II we focused during solving part of the project *Technicom (Center of Nondestructive Diagnostics of Technological Processes)* on transferring research results into practice, for example on the application of nondestructive methods in the quality control of production process. Example nondestructive technologies include laser devices and camera systems working in a wide frequency spectrum (thermovision/grayscale/color cameras) and in a variety of configurations (fast line cameras, board 2D/3D cameras). These sensors are attached to mechatronic systems (robots/manipulators/conveyors), whose nature determines the mutual sensor placement and measurement conditions for detecting the required parameters of a product or production process. Sensors and mechatronic parts usually contain custom control systems which facilitate their integration into the information and control systems of production facilities, such as the PLC control, production models, SCADA systems, relational database systems, etc.

In order to develop a quality monitoring system in laboratory conditions, we opted for an approach based on a set of model applications. Mathematical models of these applications, which included laboratory models of mechatronic or hydraulic systems, production lines and mobile robots, were derived and implemented into a suitable environment to enable subsequent simulation. Physical realization of laboratory models, equipped with sensors, actuators and control systems, was next performed. Their functionality was verified in terms of dynamical behavior (by comparing simulation and laboratory model responses) and interoperation of their distributed parts (via standard technological and program interfaces). The resulting model application can be considered as a set of hardware and software modules, each of which corresponds to a particular level of the DCS infrastructure. Examples of practical application of analyzed laboratory models were presented. Advantages of the provided solution include the open architecture of

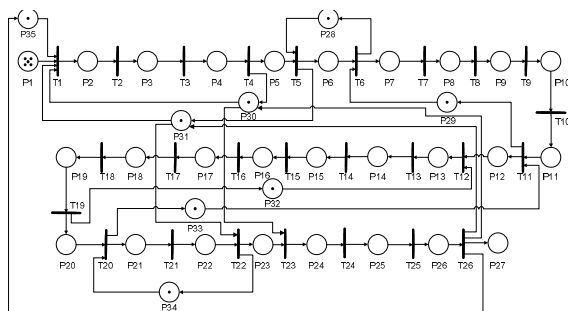

Figure 10. Flexible production system (FPS) Petri net model

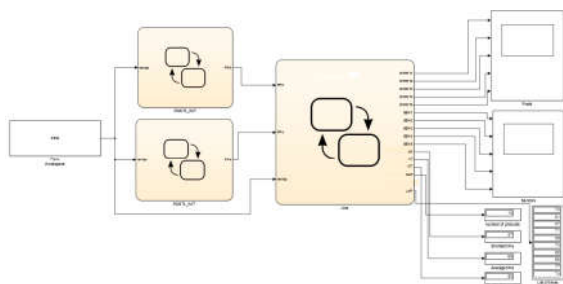

Figure 11. Flexible assembly company (FAC) Stateflow model

the system, usage of commercially available components and, above all, the developed methodology which allows to integrate quality monitoring units into existing information-control systems in a user-friendly way.

ACKNOWLEDGEMENT

This work has been supported by the Research and Development Operational Program for project: University Science Park Technicom for innovative applications with knowledge technology support, ITMS code 26220220182, co-financed by the ERDF (80%) and by grant KEGA - 001TUKE-4/2015 (20%) sponsor acknowledgments in the unnumbered footnote on the first page.

REFERENCES

- [1] J.Jadlovský, M. Čopik and P. Papcun, *Distributed control systems*, elfa Košice, 2013, 215 p., ISBN 978-80-8086-227-5 (in Slovak)
- [2] J. Čerkala and A. Jadlovská, "Dynamics with Friction in Mobile Robot Simulink Model," in *Technical Computing Bratislava 2014 Proceedings - Saarbrücken* : Lap Lambert Academic Publishing, 2015, pp. 65-81. - ISBN 978-3-659-40792-5
- [3] J. Jadlovský and M. Kopčík, "Basic Motion Control of Differential-Wheeled Mobile Robot ALFRED," in *Advances in Intelligent Systems and Computing: Emergent Trends in Robotics and Intelligent Systems - Switzerland*: Springer, vol. 316, 2015, pp. 73-80. ISSN 2194-5357
- [4] J. Jadlovský, M. Varga and M. Kopčík, "Image Processing for Localization of Mobile Robots," in *Electrical Engineering and Informatics 6 : proceedings of the Faculty of Electrical Engineering and Informatics of the Technical University of Košice - Košice*: FEI TU, 2015, pp. 574-577. ISBN 978-80-553-2178-3
- [5] A.Jadlovská and S. Jadlovská, *Modern methods of modeling and control of nonlinear systems*, elfa Košice, 2013, 257 p., ISBN 978-80-8086-228-2 (in Slovak)
- [6] S. Jadlovská, J. Sarnovský, J. Vojtek and D. Vošček, "Advanced Generalized Modelling of Classical Inverted Pendulum Systems," in *Advances in Intelligent Systems and Computing: Emergent Trends in Robotics and Intelligent Systems - Switzerland*: Springer, 2014 vol. 316, 2015, pp 255-264. - ISSN 2194-5357
- [7] S. Jadlovská, "Modeling and Optimal Control of Nonlinear Underactuated Dynamical Systems", Dissertation Theses, FEI TU Košice, 230 p., (in Slovak)
- [8] M. Oravec and A. Jadlovská, "Model Predictive Control of Ball and Plate Laboratory Model," in SAMI 2015. - Danvers: IEEE, 2015 pp. 165-170. - ISBN 978-1-4799-8220-2
- [9] J. Čerkala and A. Jadlovská, "Methodology for Experimental Identification of the Laboratory Hydraulic System," in *Annals of Faculty Engineering Hunedoara - International Journal of Engineering*, vol. 12, no. 3, 2014, pp. 33-40. - ISSN 1584-2665
- [10] P. Papcun and J. Jadlovský, "Mathematical Model of Robot Melfa RV-2SDB," in *Advances in Intelligent Systems and Computing: Emergent Trends in Robotics and Intelligent Systems - Switzerland*: Springer, vol. 316, 2015, pp. 145-154. ISSN 2194-5357
- [11] J. Čabala and J. Jadlovský, "Solving Vector Optimization Problems Using Optimization Toolbox," in *Technical Computing Bratislava 2014 Proceedings - Saarbrücken*: Lap Lambert Academic Publishing, 2015 pp. 45-64. - ISBN 978-3-659-40792-5